

DeSnifter's  
Rhino Mk I  
Template

.75mm card  
.30inch card

left side / right side  
from frontal view

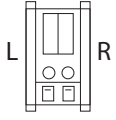

Solid Line = Cut

Dash Line = Score

Hatch = Texture Plasticard

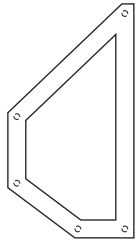

left side

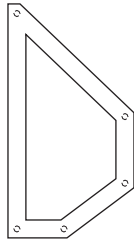

right side

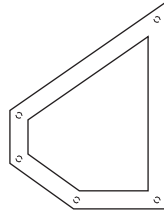

right side

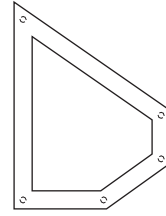

left side

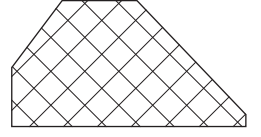

left side

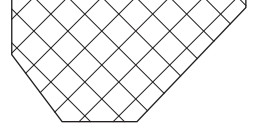
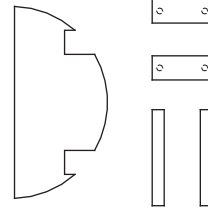
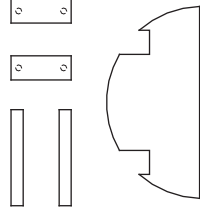
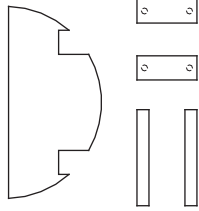
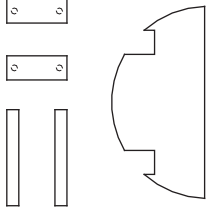

right side

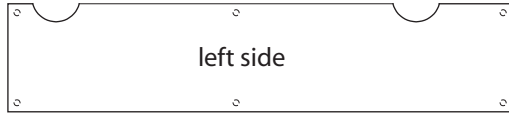

left side

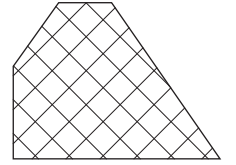

right side



right side

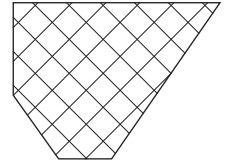

left side

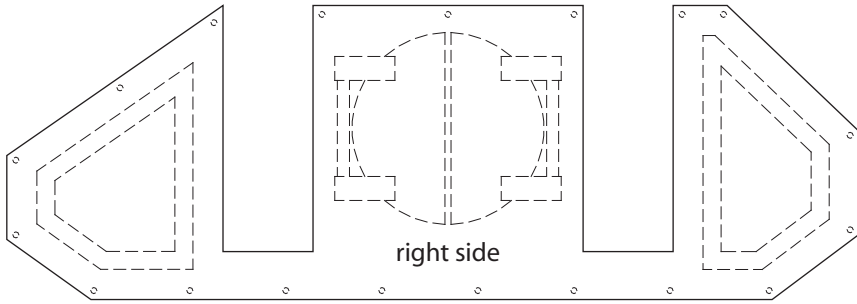

right side

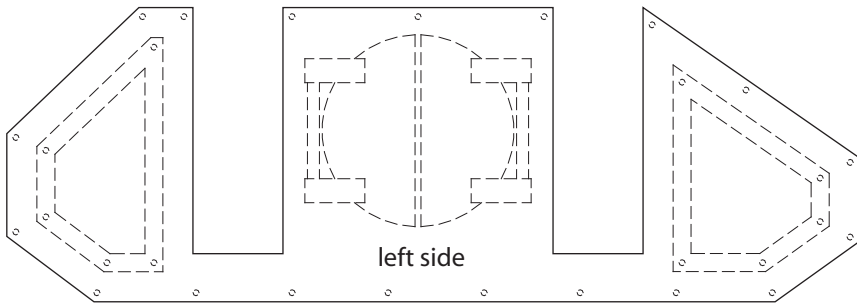
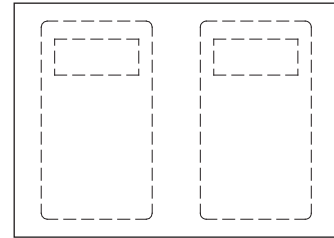

left side

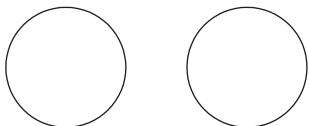
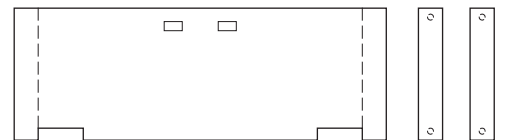
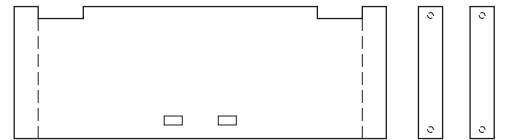
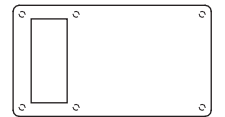
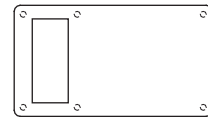

cupola spacers